

PRODUCTS CATALOG

Single Use Surgical Instruments



Single Use Instruments



SUORG is the abbreviation for "Single Use Operating Room Grade", a high class of instruments that can last through longer procedures without loss of quality or functionality.

Common Single-us metal instruments and plastic metal instruments belong to the so called "Floor Room Grade" RB Medikal offers a much higher quality in order to ensure best functionality and provide security, at comparable and least possible prices.

in all aspects a economic and highly competitive solution.



RB Medikal Single-use instruments completely fulfil the EN-ISO 15883 norm about cleaning and disinfection.

RB MEDIKAL INSTRUMENTS

Tel: +92 52 3552898 **Email:** rbmedikal@gmail.com **Web:** www.rbmedikal.com



Single Use Instruments

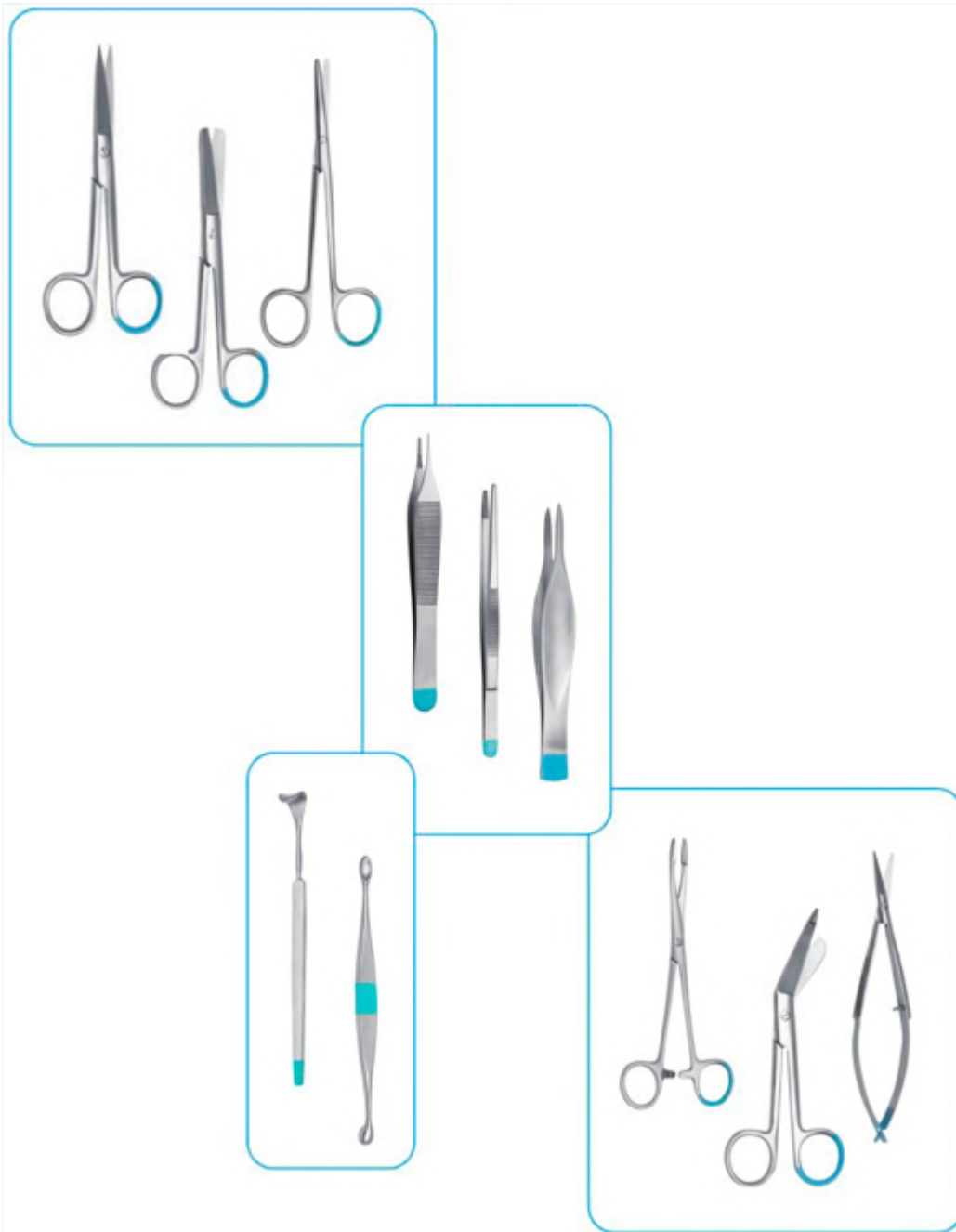

RB MEDIKAL INSTRUMENTS

Surgical scissors sh./sh., straight

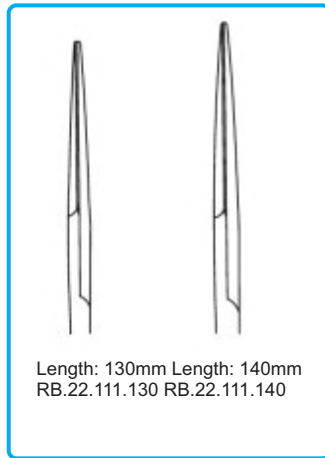

Surgical scissors sh./bl., straight

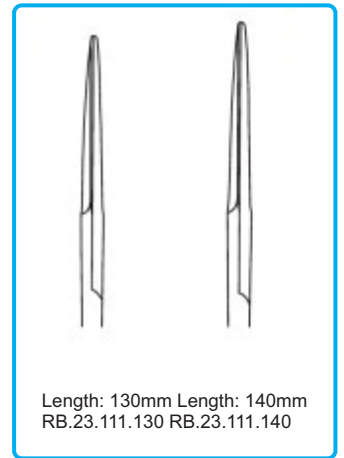

Surgical scissors bl./bl., straight

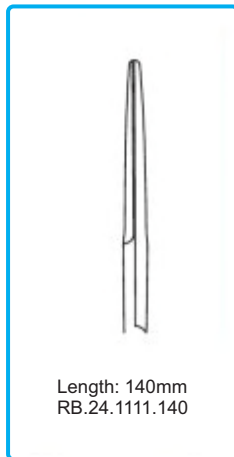

Surgical scissors sh./sh., curved

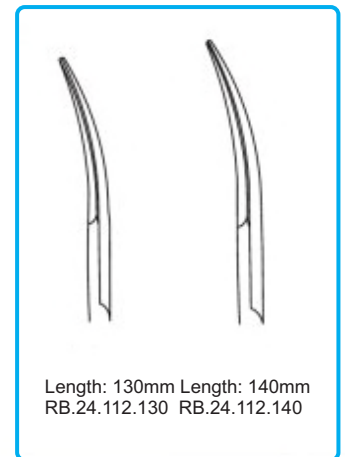

Surgical scissors sh./bl., curved

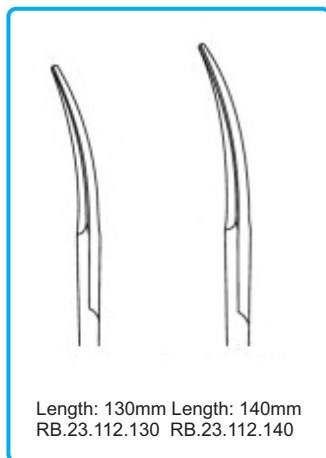

Surgical scissors bl./bl., curved

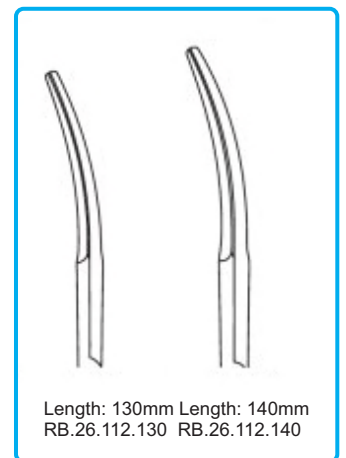



Dissecting Scissors

Metzenbaum dissecting scissors, straight

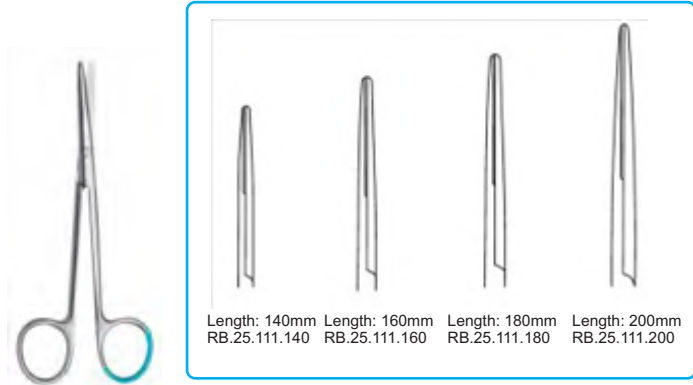

Metzenbaum dissecting scissors, curved

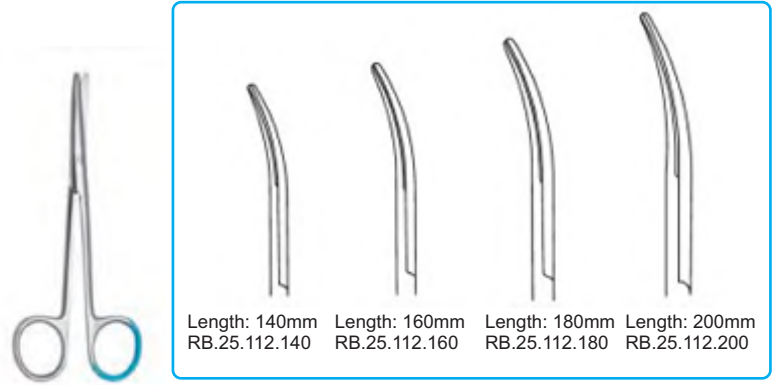

Stevens dissecting scissors, blunt, straight



Stevens dissecting scissors, blunt, curved



Mayo Dissecting Scissors, Straight



Mayo Dissecting Scissors, Curved



Universal Bandage Scissors
Floor Room Grade



Length: 180mm
RB.20.000.180

Lister bandage scissors

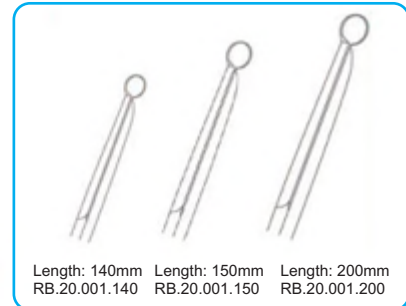

Length: 140mm RB.20.001.140
Length: 150mm RB.20.001.150
Length: 200mm RB.20.001.200

Iris Scissors, Straight

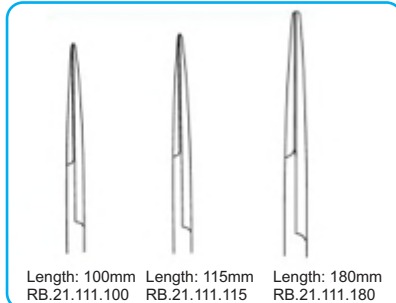

Length: 100mm RB.21.111.100
Length: 115mm RB.21.111.115
Length: 180mm RB.21.111.180

Iris Scissors, Curved

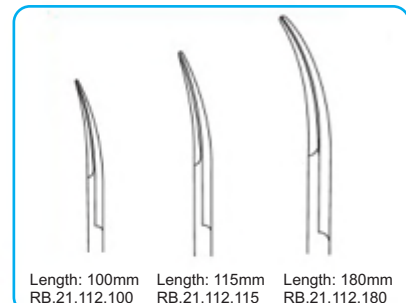

Length: 100mm RB.21.112.100
Length: 115mm RB.21.112.115
Length: 180mm RB.21.112.180

Spencer stitch / suture scissors, straight

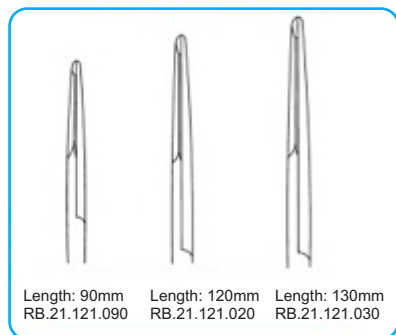

Length: 90mm RB.21.121.090
Length: 120mm RB.21.121.020
Length: 130mm RB.21.121.030

Noyes eye scissors

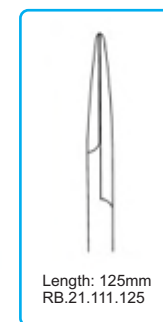

Length: 125mm
RB.21.111.125

Braun-Stadler episiotomy scissor



Length: 145mm RB.26.111.145
Length: 200mm RB.26.111.200

Episiotomy scissor

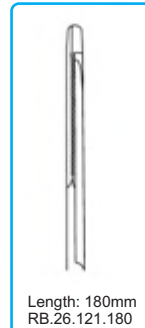

Length: 180mm
RB.26.121.180



Clamps

Maier sponge forceps, straight



Tubing clamp forceps

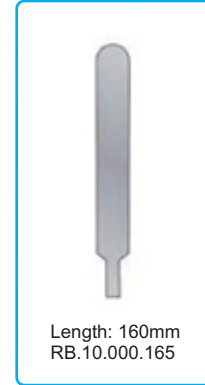

Sponge forceps, straight

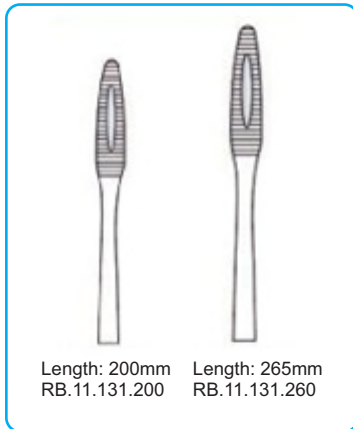

Sponge forceps, curved

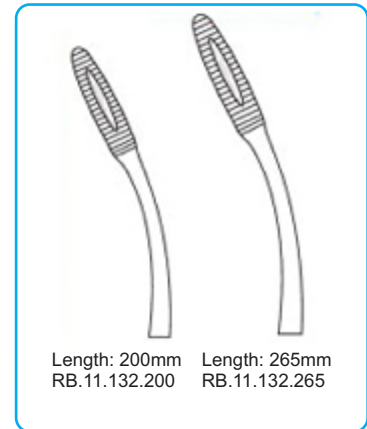

Forester sponge holding forceps, straight

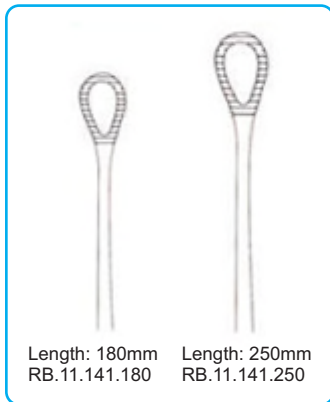

Forester sponge holding forceps, curved

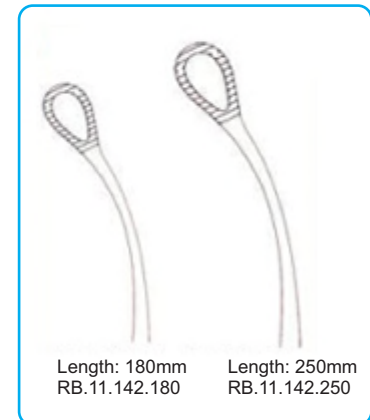

Halsted Mosquito Artery Forceps, Straight



Halsted Mosquito Artery Forceps, Curved



Birkett artery forceps, straight

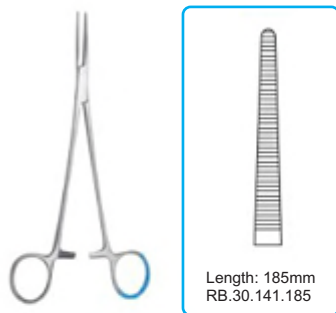

Birkett artery forceps, curved

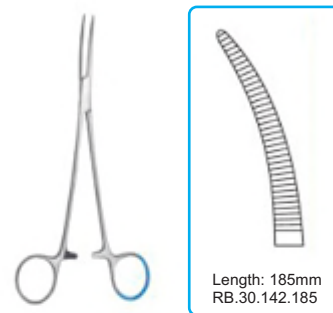

Rochester Pean Artery Forceps, straight

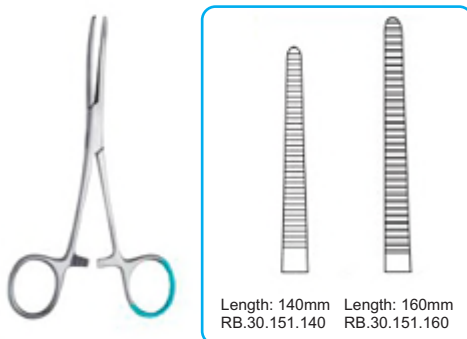

Rochester Pean Artery Forceps, curved

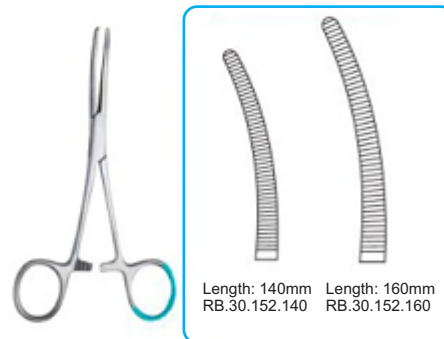

Pean artery forceps, straight





Haemostatic Forceps (anatomic)



Micro Halsted artery forceps, straight



Micro Halsted artery forceps, curved



Kelly anatomic artery forceps, straight



Kelly anatomic artery forceps, curved



Crile artery forceps, straight



Crile artery forceps, curved

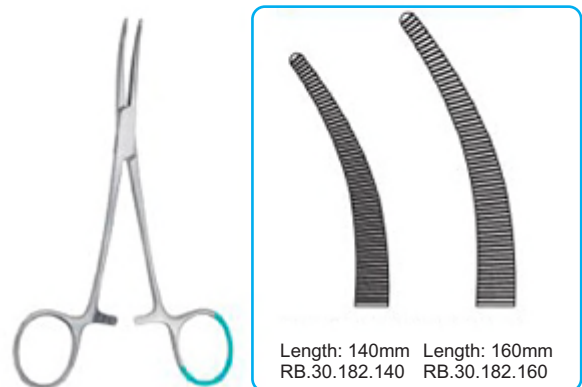

Micro halsted artery forceps, 1 x 2 teeth, straight



Micro halsted artery forceps, 1 x 2 teeth, curved

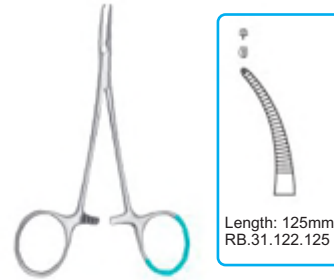

Kelly artery forceps, 1x2 teeth, straight

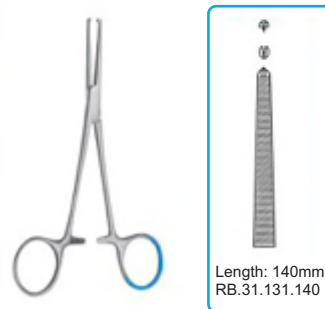

Kelly artery forceps, 1x2 teeth, curved

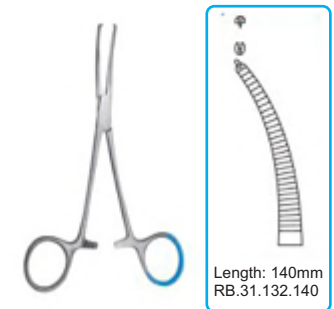

Kocher artery forceps, 1x2 teeth, straight



Kocher artery forceps, 1x2 teeth, curved



Halsted artery forceps, 1x2 teeth, straight



Halsted artery forceps, 1x2 teeth, curved





Haemostatic Forceps (surgical)

Rochester-Ochsner Artery Forceps,
1 x 2 teeth, Straight

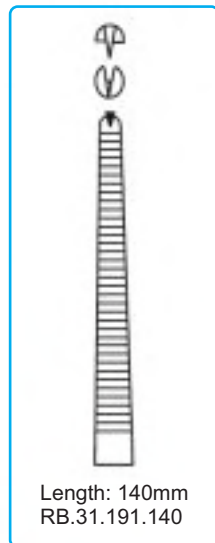

Length: 140mm
RB.31.191.140

Rochester-Ochsner Artery Forceps,
1 x 2 teeth, Curved

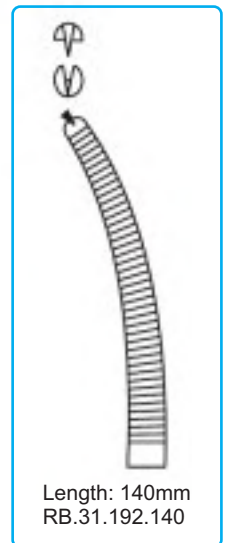

Length: 140mm
RB.31.192.140

Adson anatomic forceps

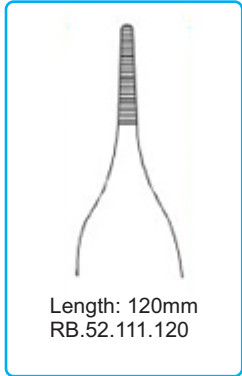

Micro-Adson anatomic forceps, Fine

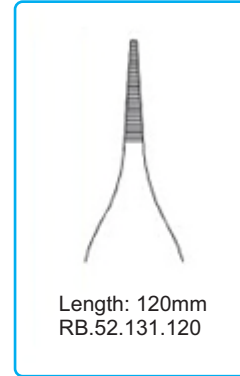

Standard anatomic tissue forceps, fine



Standard anatomic tissue forceps, fine



Cushing anatomic forceps





Adson tissue forceps, 1 x 2 teeth

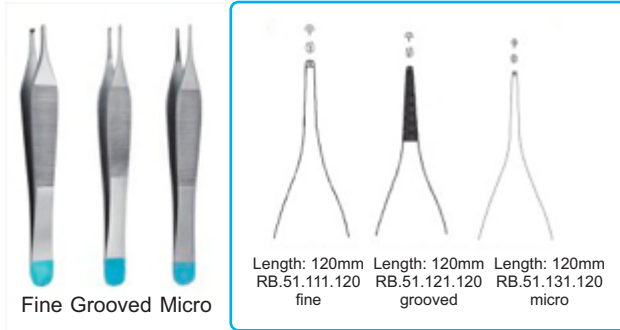

Adson-Brown tissue forceps 7 x 7 teeth

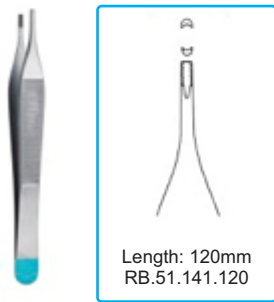

Standard tissue forceps, 1 x 2 teeth



Gillies tissue forceps, 1x2 teeth

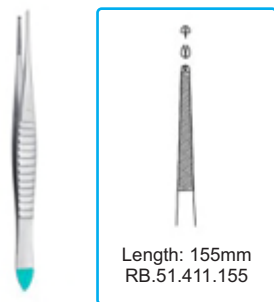

Waugh tissue forceps, 1x2 teeth



De Bakey Forceps

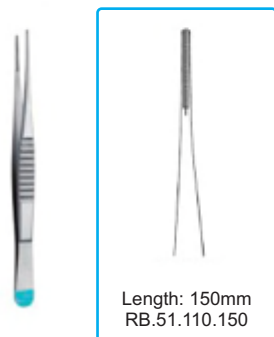

Feilchenfeld splinter forceps

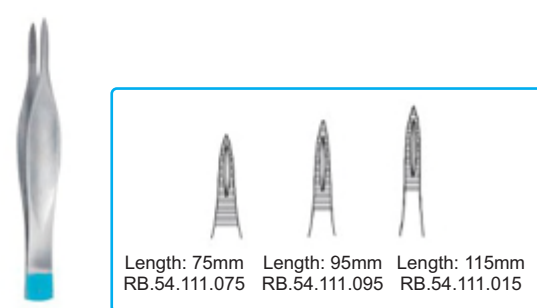

Mayo Hegar Needle Holder

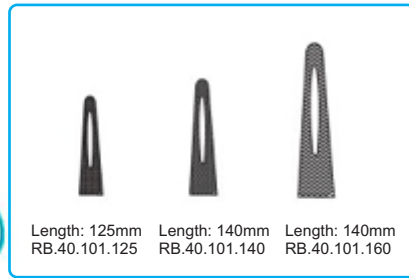

Mayo Hegar Needle Holder (spring scissors)

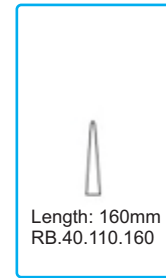

Olsen Hegar Needle Holder

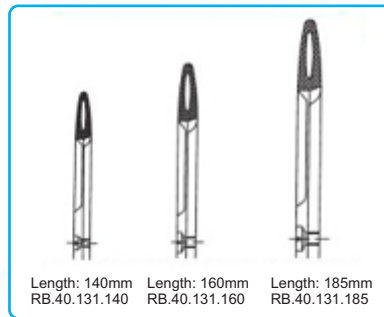

Crilewood Needle Holder



Derf needle holder

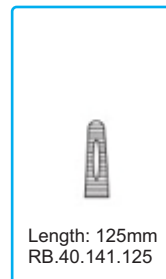



Senn-Miller retractors, double-ended, sharp



Roux Refractor



Gillies hook, skin retractor



Desmarres lid retractor with stable hook (9x12mm)



Weithlaner retractor, semi-sharp, 3x4 teeth



Willinger spoon, oval



Bone curettes, double-ended, narrow, oval/round

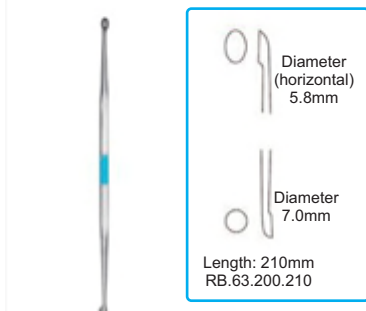

Bone curettes, double-ended, wide, oval/round

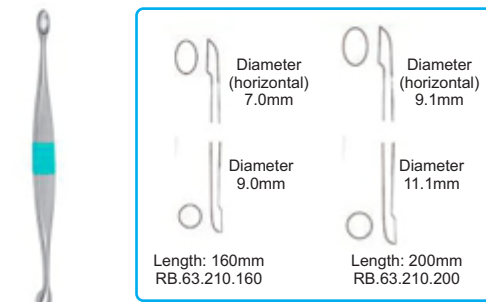

Sterile Sets for Single-Use



OR Set 1

Order Code: RB.99.400.001

1x	Metzenbaum dissecting scissors, curved, 140 mm
1x	Halsted mosquito artery forceps, curved, 125 mm
1x	Mayo-Hegar needle holder, 125 mm
1x	Adson anatomic forceps, straight, 120 mm
1x	Adson tissue forceps, 1 x 2 teeth, straight, 120mm

Ask for our wide OR Set Program!



OR Set 2

Order Code: RB.99.400.002

1x	Mayo Dissecting Scissors, Curved, 140 mm
1x	Kocher artery forceps, straight, 1 x 2 teeth, 130 mm
1x	Mayo Hegar Needle Holder, 140 mm
1x	Standard anatomic tissue forceps, fine, 145 mm
1x	Standard tissue forceps, 1 x 2 teeth, 145mm



Nursing Tools



RB.01



RB.02



RB.03



RB.03



RB.04



RB.05



RB.07



RB.08



RB.09



RB.10



RB.11



RB.12



RB.13



RB.14



RB.15



RB.16



RB.17



RB.18



RB.19



RB.20



RB.21

RB.22



RBmedikal

Electro Surgical Instruments

RB Medikal Instruments was established with a mission to provide our valued clients with impeccable service in the field of advance and update, finest quality hand crafted Electro Surgical Instruments, Single-Use Surgical Instruments. Align with our team of professionals; we always strive for a Full satisfaction of a customer which is necessary for long terms business relations. We are also continuously developing new products, upgrading our instruments in all possible ways through technological enhancements and investigating under improved methods.

We are a company that sets high standards. Our growth has come from offering an unparalleled variety of innovative, high-quality products and services resulting from the dedication of our employees.

Full satisfaction of a customer is necessary for long terms business relations. We are committed to establish a life long partnership with all of our customers. Our commitment to quality, based on our continuous monitoring at every stage of the manufacturing process has placed us at par with international standards, while maintaining very competitive prices.

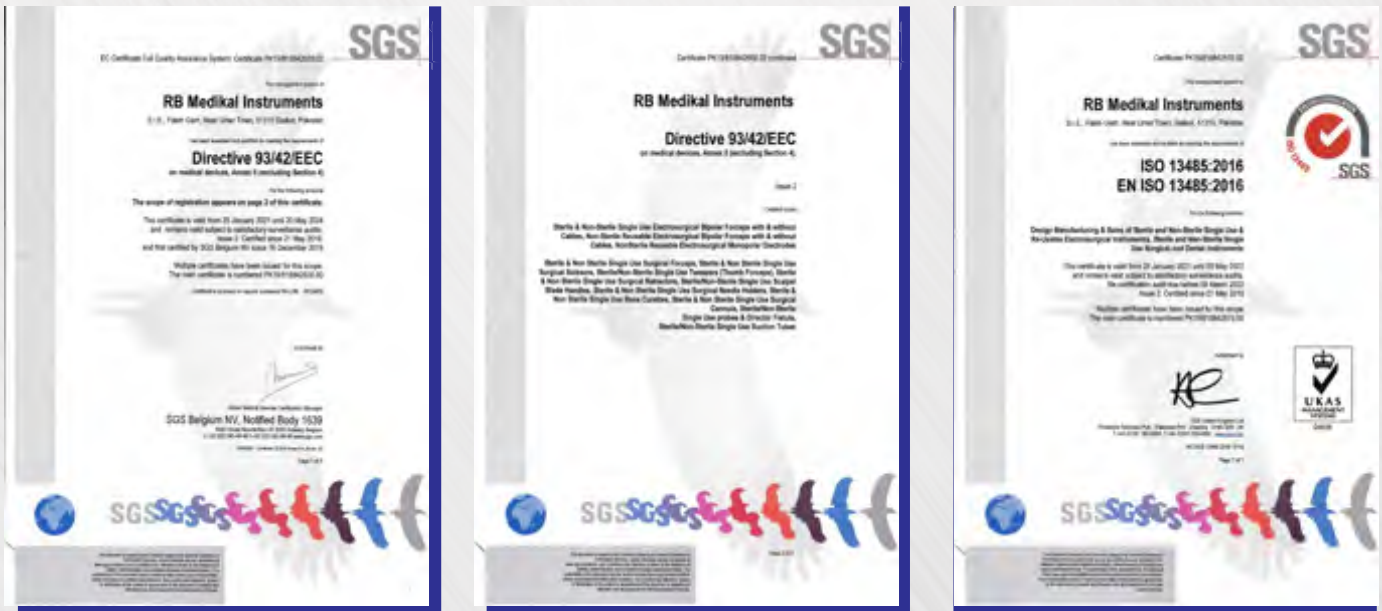



RB Medikal Instruments

Small Industrial State, Fateh Garh,
Near Umer Town, Sialkot-51310 PAKISTAN.

Tel: +92 52 3552898 / Fax: +92 52 3 576055
Email: rbmedikal@brain.net.pk / rbmedikal@gmail.com
URL: www.rbmedikal.com



Whatsapp



WeChat

0092-333-8619610